

# NL37WZ14

## Triple Schmitt-Trigger Inverter

The NL37WZ14 is a high performance triple inverter with Schmitt-Trigger inputs operating from a 1.65 to 5.5 V supply.

### Features

- Designed for 1.65 V to 5.5 V  $V_{CC}$  Operation
- 2.7 ns  $t_{PD}$  at  $V_{CC} = 5$  V (typ)
- Inputs/Outputs Overvoltage Tolerant up to 5.5 V
- $I_{OFF}$  Supports Partial Power Down Protection
- Source/Sink 24 mA at 3.0 V
- Available in US8, UDFN8 and UQFN8 Packages
- Chip Complexity < 100 FETs
- NLV Prefix for Automotive and Other Applications Requiring Unique Site and Control Change Requirements; AEC-Q100 Qualified and PPAP Capable
- These Devices are Pb-Free, Halogen Free/BFR Free and are RoHS Compliant

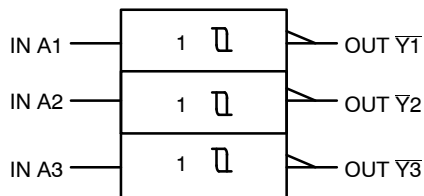

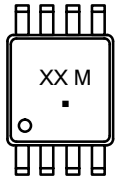

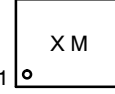

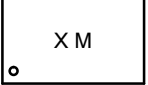





Figure 1. Logic Symbol



**ON Semiconductor®**

[www.onsemi.com](http://www.onsemi.com)

		MARKING DIAGRAMS
	<b>US8 US SUFFIX CASE 493</b>	
	<b>UDFN8, 1.45x1.0 MU3 SUFFIX CASE 517BZ</b>	
	<b>UDFN8, 1.95x1.0 MU1 SUFFIX CASE 517CA</b>	
	<b>UQFN8, 1.4x1.2 MQ2 SUFFIX CASE 523AS</b>	
	<b>UQFN8, 1.6x1.6 MQ1 SUFFIX CASE 523AN</b>	

X, XX = Specific Device Code  
M = Date Code\*  
▪ = Pb-Free Package

### ORDERING INFORMATION

See detailed ordering, marking and shipping information in the package dimensions section on page 6 of this data sheet.

# NL37WZ14

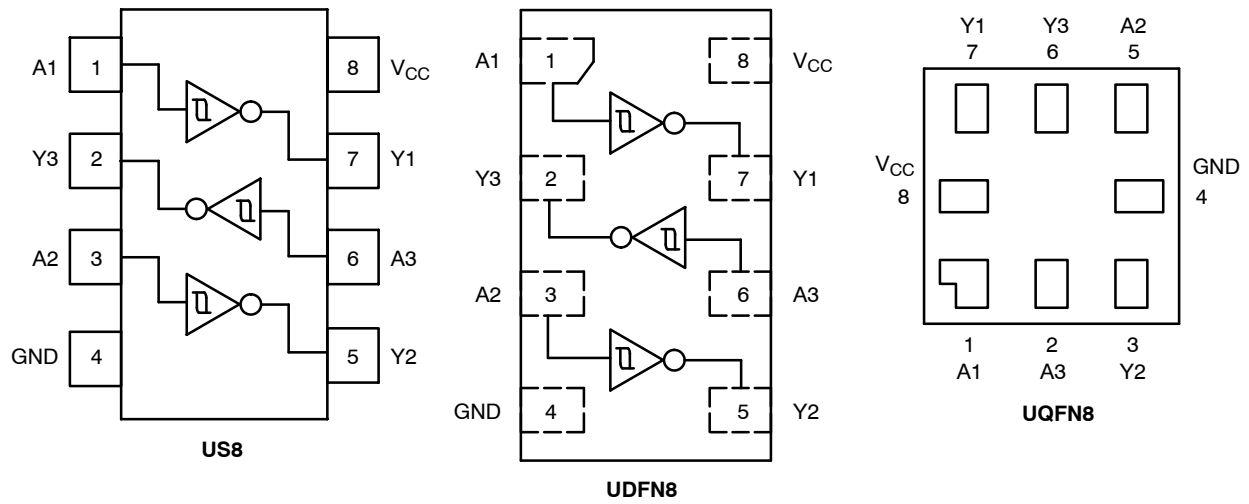

Figure 2. Pinout

## PIN ASSIGNMENT

Pin	Function
1	A1
2	Y3
3	A2
4	GND
5	Y2
6	A3
7	Y1
8	V <sub>CC</sub>

## FUNCTION TABLE

A Input	$\bar{Y}$ Output
L	H
H	L

# NL37WZ14

## MAXIMUM RATINGS

Symbol	Characteristics	Value	Unit	
V <sub>CC</sub>	DC Supply Voltage	-0.5 to +6.5	V	
V <sub>IN</sub>	DC Input Voltage	-0.5 to +6.5	V	
	DC Output Voltage	Active-Mode (High or Low State) Tri-State Mode (Note 1) Power-Down Mode (V <sub>CC</sub> = 0 V)	-0.5 to V <sub>CC</sub> + 0.5 -0.5 to +6.5 -0.5 to +6.5	V
I <sub>IK</sub>	DC Input Diode Current	V <sub>IN</sub> < GND	-50	mA
I <sub>OK</sub>	DC Output Diode Current	V <sub>OUT</sub> < GND	-50	mA
I <sub>OUT</sub>	DC Output Source/Sink Current		±50	mA
I <sub>CC</sub> or I <sub>GND</sub>	DC Supply Current per Supply Pin or Ground Pin		±100	mA
T <sub>STG</sub>	Storage Temperature Range		-65 to +150	°C
T <sub>L</sub>	Lead Temperature, 1 mm from Case for 10 secs		260	°C
T <sub>J</sub>	Junction Temperature Under Bias		+150	°C
θ <sub>JA</sub>	Thermal Resistance (Note 2)	US8	250	°C/W
		UQFN8	208	
		UDFN	111	
P <sub>D</sub>	Power Dissipation in Still Air	US8	250	mW
		UDFN8	601	
		UDFN	1127	
MSL	Moisture Sensitivity		Level 1	-
F <sub>R</sub>	Flammability Rating	Oxygen Index: 28 to 34	UL 94 V-0 @ 0.125 in	-
V <sub>ESD</sub>	ESD Withstand Voltage (Note 3)	Human Body Model	2000	V
		Charged Device Model	1000	
I <sub>Latchup</sub>	Latchup Performance (Note 4)		± 100	mA

Stresses exceeding those listed in the Maximum Ratings table may damage the device. If any of these limits are exceeded, device functionality should not be assumed, damage may occur and reliability may be affected.

1. Applicable to devices with outputs that may be tri-stated.
2. Measured with minimum pad spacing on an FR4 board, using 10mm-by-1inch, 2 ounce copper trace no air flow.
3. HBM tested to ANSI/ESDA/JEDEC JS-001-2017. CDM tested to EIA/JESD22-C101-F. JEDEC recommends that ESD qualification to EIA/JESD22-A115-A (Machine Model) be discontinued per JEDEC/JEP172A.
4. Tested to EIA/JESD78 Class II.

## RECOMMENDED OPERATING CONDITIONS

Symbol	Characteristics	Min	Max	Unit	
V <sub>CC</sub>	Positive DC Supply Voltage	2.3	5.5	V	
V <sub>IN</sub>	DC Input Voltage	0	5.5	V	
V <sub>OUT</sub>	DC Output Voltage	Active-Mode (High or Low State)	V <sub>CC</sub>		
		Tri-State Mode (Note 1)	5.5		
		Power-Down Mode (V <sub>CC</sub> = 0 V)	5.5		
T <sub>A</sub>	Operating Temperature Range	-55	+125	°C	
t <sub>r</sub> , t <sub>f</sub>	Input Rise and Fall Time	V <sub>CC</sub> = 1.65 V to 1.95 V	0	20	ns/V
		V <sub>CC</sub> = 2.3 V to 2.7 V	0	20	
		V <sub>CC</sub> = 3.0 V to 3.6 V	0	10	
		V <sub>CC</sub> = 4.5 V to 5.5 V	0	5	

Functional operation above the stresses listed in the Recommended Operating Ranges is not implied. Extended exposure to stresses beyond the Recommended Operating Ranges limits may affect device reliability.

# NL37WZ14

## DC ELECTRICAL CHARACTERISTICS

Symbol	Parameter	Condition	V <sub>CC</sub> (V)	T <sub>A</sub> = 25°C			-55°C ≤ T <sub>A</sub> ≤ 125°C		Units
				Min	Typ	Max	Min	Max	
V <sub>T+</sub>	Positive Input Threshold Voltage		2.3	-	1.5	1.8	-	1.8	V
			2.7	-	1.7	2.0	-	2.0	
			3.0	-	1.9	2.2	-	2.2	
			4.5	-	2.7	3.1	-	3.1	
			5.5	-	3.3	3.6	-	3.6	
V <sub>T-</sub>	Negative Input		2.3	0.4	0.75	-	0.4	-	V
			2.7	0.5	0.87	-	0.5	-	
			3.0	0.6	1.0	-	0.6	-	
			4.5	1.0	1.5	-	1.0	-	
			5.5	1.2	1.9	-	1.2	-	
V <sub>H</sub>	Input Hysteresis Voltage		2.3	0.25	0.75	1.1	1.25	1.1	V
			2.7	0.3	0.83	1.15	0.3	1.15	
			3.0	0.4	0.93	1.2	0.4	1.2	
			4.5	0.6	1.2	1.5	0.6	1.5	
			5.5	0.7	1.4	1.7	0.7	1.7	
V <sub>OH</sub>	High-Level Output Voltage	V <sub>IN</sub> = V <sub>IH</sub> or V <sub>IL</sub> I <sub>OH</sub> = -100 μA	1.65 to 5.5	V <sub>CC</sub> - 0.1	V <sub>CC</sub>	-	V <sub>CC</sub> - 0.1	-	V
		I <sub>OH</sub> = -4 mA	1.65	1.29	1.4	-	1.29	-	
		I <sub>OH</sub> = -8 mA	2.3	1.9	2.1	-	1.9	-	
		I <sub>OH</sub> = -12 mA	2.7	2.2	2.4	-	2.2	-	
		I <sub>OH</sub> = -16 mA	3.0	2.4	2.7	-	2.4	-	
		I <sub>OH</sub> = -24 mA	3.0	2.3	2.5	-	2.3	-	
		I <sub>OH</sub> = -32 mA	4.5	3.8	4.0	-	3.8	-	
V <sub>OL</sub>	Low-Level Output Voltage	V <sub>IN</sub> = V <sub>IH</sub> or V <sub>IL</sub> I <sub>OL</sub> = 100 μA	1.65 to 5.5	-		0.1	-	0.1	V
		I <sub>OL</sub> = 4 mA	1.65	-	0.08	0.24	-	0.24	
		I <sub>OL</sub> = 8 mA	2.3	-	0.2	0.3	-	0.3	
		I <sub>OL</sub> = 12 mA	2.7	-	0.22	0.4	-	0.4	
		I <sub>OL</sub> = 16 mA	3.0	-	0.28	0.4	-	0.4	
		I <sub>OL</sub> = 24 mA	3.0	-	0.38	0.55	-	0.55	
		I <sub>OL</sub> = 32 mA	4.5	-	0.42	0.55	-	0.55	
I <sub>IN</sub>	Input Leakage Current	V <sub>IN</sub> = 5.5 V or GND	1.65 to 5.5	-	-	±0.1	-	±1.0	μA
I <sub>OFF</sub>	Power Off Leakage Current	V <sub>IN</sub> = 5.5 V or V <sub>OUT</sub> = 5.5 V	0	-	-	1.0	-	10	μA
I <sub>CC</sub>	Quiescent Supply Current	V <sub>IN</sub> = V <sub>CC</sub> or GND	5.5	-	-	1.0	-	10	μA

Product parametric performance is indicated in the Electrical Characteristics for the listed test conditions, unless otherwise noted. Product performance may not be indicated by the Electrical Characteristics if operated under different conditions.

## AC ELECTRICAL CHARACTERISTICS (Input t<sub>r</sub> = t<sub>f</sub> = 3.0 ns)

Symbol	Parameter	V <sub>CC</sub> (V)	Test Conditions	T <sub>A</sub> = 25°C			T <sub>A</sub> = -55 to 125°C		Units
				Min	Typ	Max	Min	Max	
t <sub>PLH</sub> , t <sub>PHL</sub>	Propagation Delay	2.5 ± 0.2	C <sub>L</sub> = 15 pF R <sub>D</sub> = 1 MΩ R <sub>1</sub> = Open	-	3.8	7.5	-	8.0	ns
		3.3 ± 0.3		-	2.8	6.5	-	7.0	
		5.0 ± 0.5		-	2.2	4.5	-	5.0	
		3.3 ± 0.3	C <sub>L</sub> = 50 pF, R <sub>D</sub> = 500 Ω, R <sub>1</sub> = Open	-	3.4	7.0	-	7.5	
		5.0 ± 0.5		-	2.6	5.0	-	5.5	

## CAPACITIVE CHARACTERISTICS (t<sub>R</sub> = t<sub>F</sub> = 3.0 ns)

Symbol	Parameter	Condition	Typical	Units
C <sub>IN</sub>	Input Capacitance	V <sub>CC</sub> = 5.5 V, V <sub>IN</sub> = 0 V or V <sub>CC</sub>	2.5	pF
C <sub>OUT</sub>	Output Capacitance	V <sub>CC</sub> = 5.5 V, V <sub>IN</sub> = 0 V or V <sub>CC</sub>	2.5	pF
C <sub>PD</sub>	Power Dissipation Capacitance (Note 5)	10 MHz, V <sub>CC</sub> = 3.3 V, V <sub>IN</sub> = 0 V or V <sub>CC</sub> 10 MHz, V <sub>CC</sub> = 5.5 V, V <sub>IN</sub> = 0 V or V <sub>CC</sub>	9 11	pF

# NL37WZ14

5.  $C_{PD}$  is defined as the value of the internal equivalent capacitance which is calculated from the operating current consumption without load. Average operating current can be obtained by the equation:  $I_{CC(OPR)} = C_{PD} \cdot V_{CC} \cdot f_{in} + I_{CC}$ .  $C_{PD}$  is used to determine the no-load dynamic power consumption;  $P_D = C_{PD} \cdot V_{CC}^2 \cdot f_{in} + I_{CC} \cdot V_{CC}$ .

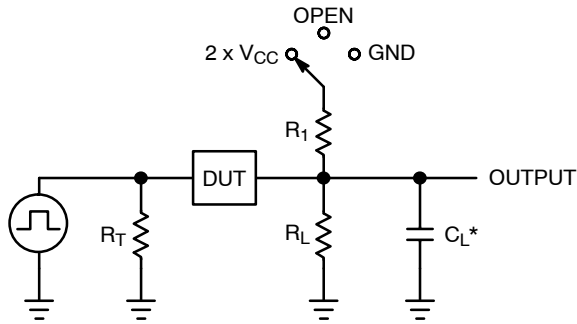

$C_L$  includes probe and jig capacitance  
 $R_T$  is  $Z_{OUT}$  of pulse generator (typically 50  $\Omega$ )  
 $f = 1$  MHz

**Figure 3. Test Circuit**

Test	Switch Position	$C_L$ , pF	$R_L$ , $\Omega$	$R_1$ , $\Omega$
$t_{PLH} / t_{PHL}$	Open	See AC Characteristics Table		
$t_{PLZ} / t_{PZL}$	$2 \times V_{CC}$	50	500	500
$t_{PHZ} / t_{PZH}$	GND	50	500	500

X = Don't Care

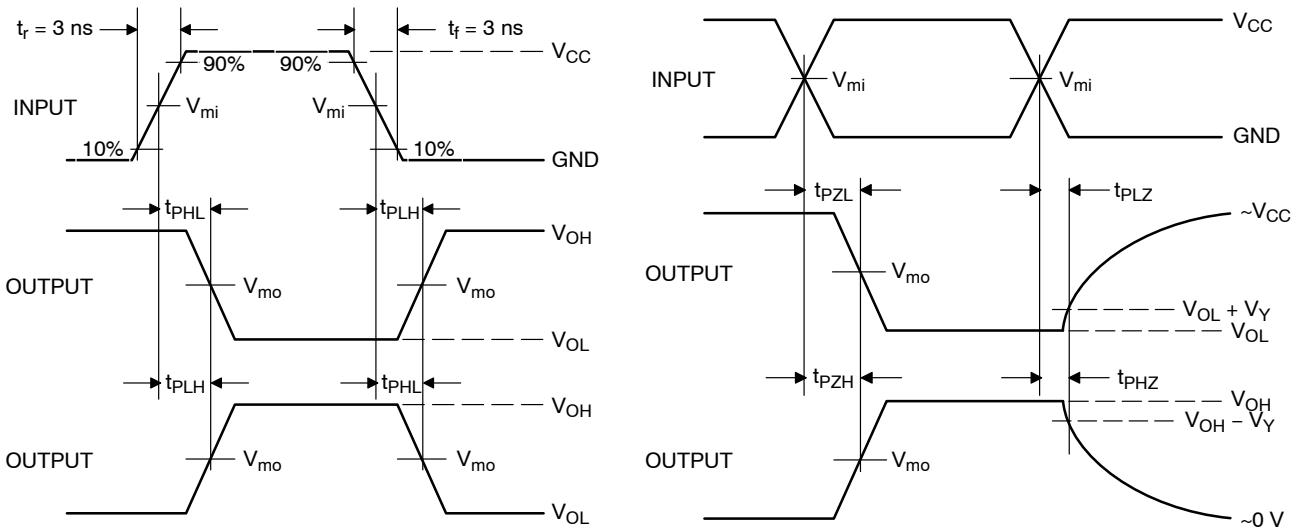

**Figure 4. Switching Waveforms**

$V_{CC}$ , V	$V_{mi}$ , V	$V_{mo}$ , V		$V_y$ , V
		$t_{PLH}, t_{PHL}$	$t_{PZL}, t_{PLZ}, t_{PZH}, t_{PHZ}$	
1.65 to 1.95	$V_{CC}/2$	$(V_{OH} - V_{OL})/2$	$V_{CC}/2$	0.15
2.3 to 2.7	$V_{CC}/2$	$(V_{OH} - V_{OL})/2$	$V_{CC}/2$	0.15
3.0 to 3.6	$V_{CC}/2$	$(V_{OH} - V_{OL})/2$	$V_{CC}/2$	0.3
4.5 to 5.5	$V_{CC}/2$	$(V_{OH} - V_{OL})/2$	$V_{CC}/2$	0.3

# NL37WZ14

## DEVICE ORDERING INFORMATION

Device	Packages	Specific Device Code	Pin 1 Orientation (See below)	Shipping <sup>†</sup>
NL37WZ14USG	US8	LA	Q4	3000 / Tape & Reel
NLV37WZ14USG*	US8	LA	Q4	3000 / Tape & Reel
NL37WZ14MQ1TCG (In Development)	UQFN8, 1.6 x 1.6, 0.5P	TBD	TBD	3000 / Tape & Reel
NL37WZ14MU1TCG (In Development)	UDFN8, 1.95 x 1.0, 0.5P	TBD	TBD	3000 / Tape & Reel
NL37WZ14MU3TCG (In Development)	UDFN8, 1.45 x 1.0, 0.5P	2	Q4	3000 / Tape & Reel
NL37WZ14MQ2TCG (In Development)	UQFN8, 1.4 x 1.2, 0.5P	TBD	TBD	3000 / Tape & Reel
NL37WZ14 (In Development)	SM8	TBD	TBD	3000 / Tape & Reel

†For information on tape and reel specifications, including part orientation and tape sizes, please refer to our Tape and Reel Packaging Specifications Brochure, BRD8011/D.

\*NLV Prefix for Automotive and Other Applications Requiring Unique Site and Control Change Requirements; AEC-Q100 Qualified and PPAP Capable.

### Pin 1 Orientation in Tape and Reel

Direction of Feed

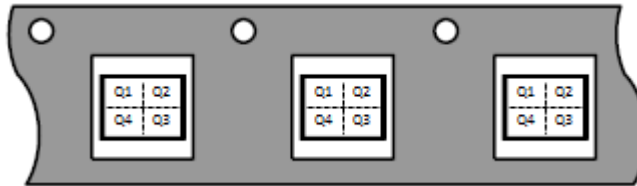

# NL37WZ14

## PACKAGE DIMENSIONS

US8  
US SUFFIX  
CASE 493-02  
ISSUE B

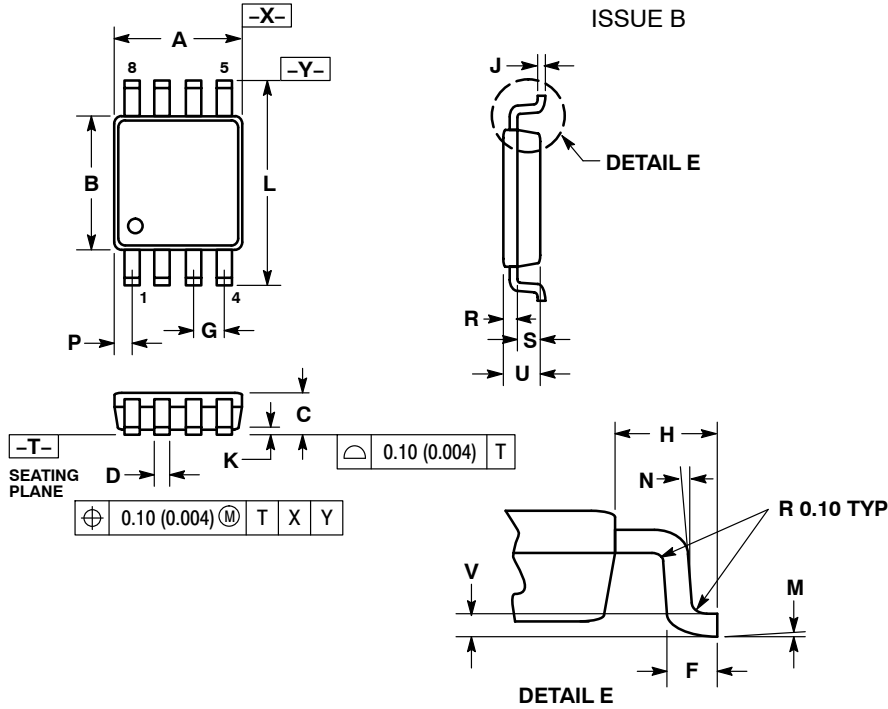

- NOTES:
1. DIMENSIONING AND TOLERANCING PER ANSI Y14.5M, 1982.
  2. CONTROLLING DIMENSION: MILLIMETERS.
  3. DIMENSION "A" DOES NOT INCLUDE MOLD FLASH, PROTRUSION OR GATE BURR. MOLD FLASH, PROTRUSION AND GATE BURR SHALL NOT EXCEED 0.140 MM (0.0055") PER SIDE.
  4. DIMENSION "B" DOES NOT INCLUDE INTER-LEAD FLASH OR PROTRUSION. INTER-LEAD FLASH AND PROTRUSION SHALL NOT EXCEED 0.140 (0.0055") PER SIDE.
  5. LEAD FINISH IS SOLDER PLATING WITH THICKNESS OF 0.0076-0.0203 MM. (300-800 °).
  6. ALL TOLERANCE UNLESS OTHERWISE SPECIFIED ±0.0508 (0.0002").

DIM	MILLIMETERS		INCHES	
	MIN	MAX	MIN	MAX
A	1.90	2.10	0.075	0.083
B	2.20	2.40	0.087	0.094
C	0.60	0.90	0.024	0.035
D	0.17	0.25	0.007	0.010
F	0.20	0.35	0.008	0.014
G	0.50 BSC		0.020 BSC	
H	0.40 REF		0.016 REF	
J	0.10	0.18	0.004	0.007
K	0.00	0.10	0.000	0.004
L	3.00	3.20	0.118	0.126
M	0°	6°	0°	6°
N	5°	10°	5°	10°
P	0.23	0.34	0.010	0.013
R	0.23	0.33	0.009	0.013
S	0.37	0.47	0.015	0.019
U	0.60	0.80	0.024	0.031
V	0.12 BSC		0.005 BSC	

### SOLDERING FOOTPRINT\*

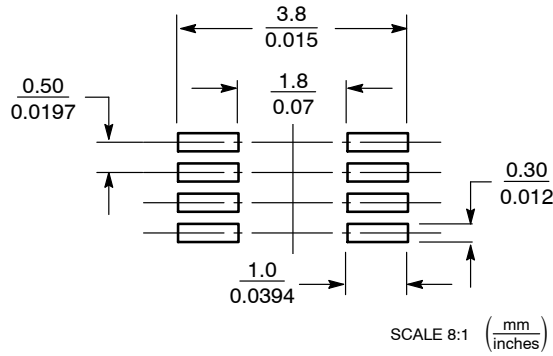

\*For additional information on our Pb-Free strategy and soldering details, please download the ON Semiconductor Soldering and Mounting Techniques Reference Manual, SOLDERRM/D.

# NL37WZ14

## PACKAGE DIMENSIONS

UDFN8, 1.45x1, 0.35P  
CASE 517BZ  
ISSUE O

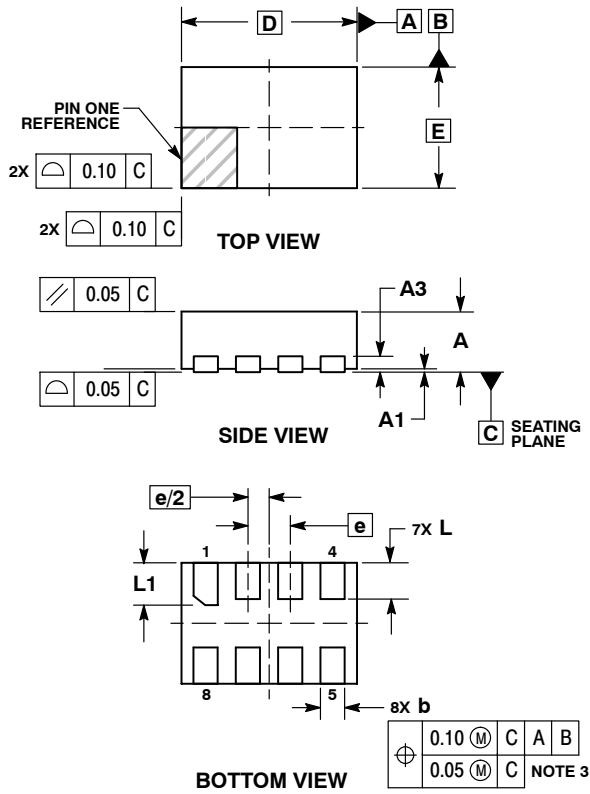

**NOTES:**

1. DIMENSIONING AND TOLERANCING PER ASME Y14.5M, 1994.
2. CONTROLLING DIMENSION: MILLIMETERS.
3. DIMENSION b APPLIES TO PLATED TERMINAL AND IS MEASURED BETWEEN 0.15 AND 0.20 MM FROM TERMINAL TIP.
4. PACKAGE DIMENSIONS EXCLUSIVE OF BURRS AND MOLD FLASH.

MILLIMETERS		
DIM	MIN	MAX
A	0.45	0.55
A1	0.00	0.05
A3	0.13 REF	
b	0.15	0.25
D	1.45 BSC	
E	1.00 BSC	
e	0.35 BSC	
L	0.25	0.35
L1	0.30	0.40

**RECOMMENDED SOLDERING FOOTPRINT\***

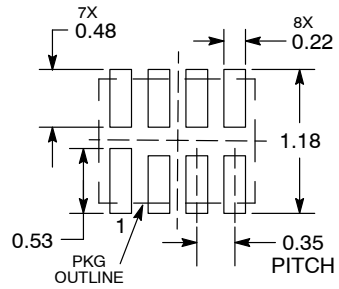

DIMENSIONS: MILLIMETERS

\*For additional information on our Pb-Free strategy and soldering details, please download the ON Semiconductor Soldering and Mounting Techniques Reference Manual, SOLDERRM/D.



# NL37WZ14

## PACKAGE DIMENSIONS

UDFN8, 1.95x1, 0.5P  
CASE 517CA  
ISSUE O

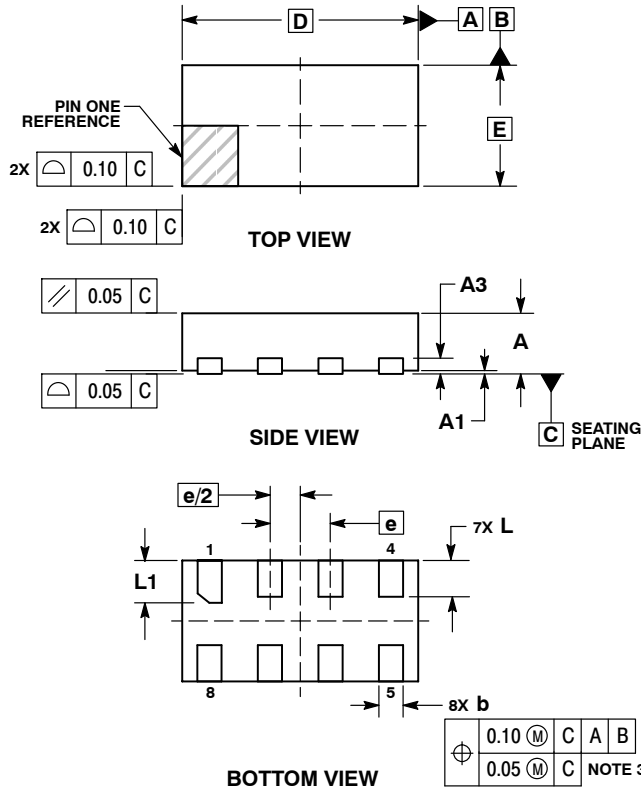

NOTES:

1. DIMENSIONING AND TOLERANCING PER ASME Y14.5M, 1994.
2. CONTROLLING DIMENSION: MILLIMETERS.
3. DIMENSION b APPLIES TO PLATED TERMINAL AND IS MEASURED BETWEEN 0.15 AND 0.20 MM FROM TERMINAL TIP.
4. PACKAGE DIMENSIONS EXCLUSIVE OF BURRS AND MOLD FLASH.

MILLIMETERS		
DIM	MIN	MAX
A	0.45	0.55
A1	0.00	0.05
A3	0.13 REF	
b	0.15	0.25
D	1.95 BSC	
E	1.00 BSC	
e	0.50 BSC	
L	0.25	0.35
L1	0.30	0.40

### RECOMMENDED SOLDERING FOOTPRINT\*

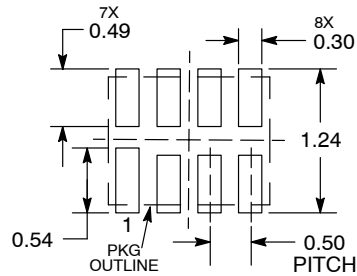

DIMENSIONS: MILLIMETERS

\*For additional information on our Pb-Free strategy and soldering details, please download the ON Semiconductor Soldering and Mounting Techniques Reference Manual, SOLDERRM/D.

# NL37WZ14

## PACKAGE DIMENSIONS

UQFN8, 1.4x1.2, 0.4P  
CASE 523AS  
ISSUE A

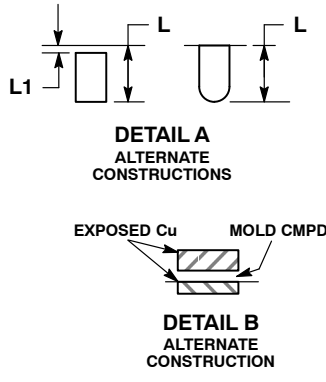
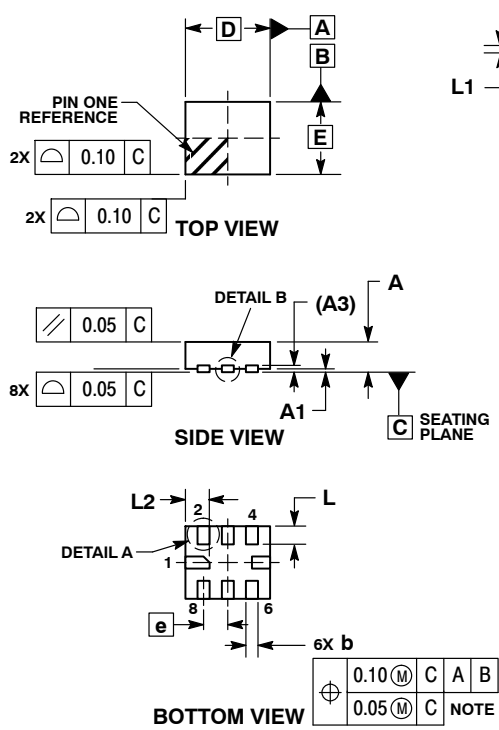

- NOTES:
1. DIMENSIONING AND TOLERANCING PER ASME Y14.5M, 1994.
  2. CONTROLLING DIMENSION: MILLIMETERS.
  3. DIMENSION b APPLIES TO PLATED TERMINAL AND IS MEASURED BETWEEN 0.15 AND 0.25 mm FROM THE TERMINAL TIP.

MILLIMETERS		
DIM	MIN	MAX
A	0.45	0.55
A1	0.00	0.05
A3	0.13	REF
b	0.15	0.25
D	1.40	BSC
E	1.20	BSC
e	0.40	BSC
L	0.20	0.40
L1	---	0.15
L2	0.30	0.50

### SOLDERING FOOTPRINT\*

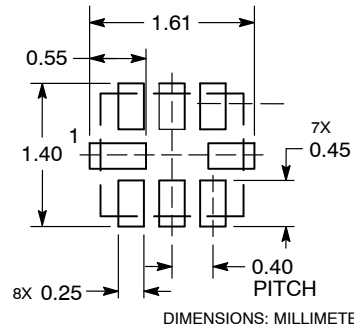

\*For additional information on our Pb-Free strategy and soldering details, please download the ON Semiconductor Soldering and Mounting Techniques Reference Manual, SOLDERRM/D.

# NL37WZ14

## PACKAGE DIMENSIONS

### UQFN8, 1.6x1.6, 0.5P CASE 523AN ISSUE O

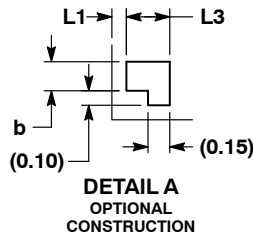
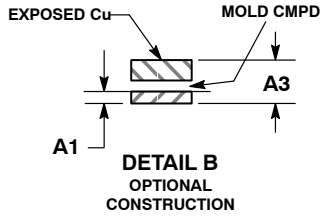
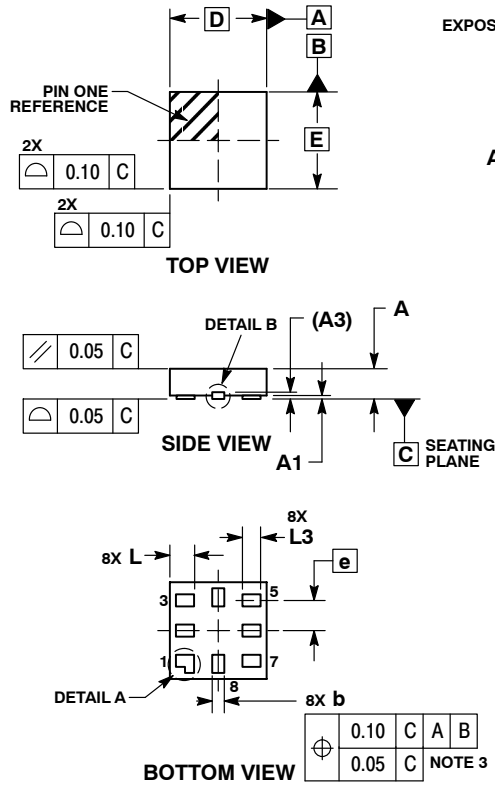

**NOTES:**

1. DIMENSIONING AND TOLERANCING PER ASME Y14.5M, 1994.
2. CONTROLLING DIMENSION: MILLIMETERS.
3. DIMENSION b APPLIES TO PLATED TERMINAL AND IS MEASURED BETWEEN 0.15 AND 0.30 mm FROM THE TERMINAL TIP.

MILLIMETERS		
DIM	MIN	MAX
A	0.45	0.60
A1	0.00	0.05
A3	0.13	REF
b	0.15	0.25
D	1.60	BSC
E	1.60	BSC
e	0.50	BSC
L	0.35	0.45
L1	---	0.15
L3	0.25	0.35

**SOLDERING FOOTPRINT\***

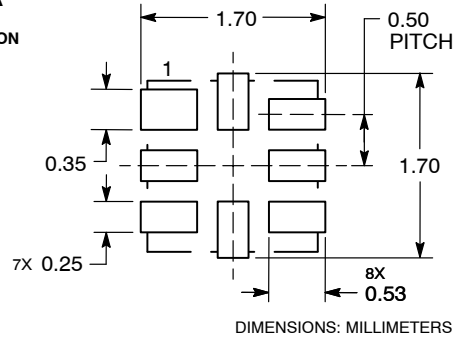

\*For additional information on our Pb-Free strategy and soldering details, please download the ON Semiconductor Soldering and Mounting Techniques Reference Manual, SOLDERRM/D.

ON Semiconductor and are trademarks of Semiconductor Components Industries, LLC dba ON Semiconductor or its subsidiaries in the United States and/or other countries. ON Semiconductor owns the rights to a number of patents, trademarks, copyrights, trade secrets, and other intellectual property. A listing of ON Semiconductor's product/patent coverage may be accessed at [www.onsemi.com/site/pdf/Patent-Marking.pdf](http://www.onsemi.com/site/pdf/Patent-Marking.pdf). ON Semiconductor reserves the right to make changes without further notice to any products herein. ON Semiconductor makes no warranty, representation or guarantee regarding the suitability of its products for any particular purpose, nor does ON Semiconductor assume any liability arising out of the application or use of any product or circuit, and specifically disclaims any and all liability, including without limitation special, consequential or incidental damages. Buyer is responsible for its products and applications using ON Semiconductor products, including compliance with all laws, regulations and safety requirements or standards, regardless of any support or applications information provided by ON Semiconductor. "Typical" parameters which may be provided in ON Semiconductor data sheets and/or specifications can and do vary in different applications and actual performance may vary over time. All operating parameters, including "Typicals" must be validated for each customer application by customer's technical experts. ON Semiconductor does not convey any license under its patent rights nor the rights of others. ON Semiconductor products are not designed, intended, or authorized for use as a critical component in life support systems or any FDA Class 3 medical devices or medical devices with a same or similar classification in a foreign jurisdiction or any devices intended for implantation in the human body. Should Buyer purchase or use ON Semiconductor products for any such unintended or unauthorized application, Buyer shall indemnify and hold ON Semiconductor and its officers, employees, subsidiaries, affiliates, and distributors harmless against all claims, costs, damages, and expenses, and reasonable attorney fees arising out of, directly or indirectly, any claim of personal injury or death associated with such unintended or unauthorized use, even if such claim alleges that ON Semiconductor was negligent regarding the design or manufacture of the part. ON Semiconductor is an Equal Opportunity/Affirmative Action Employer. This literature is subject to all applicable copyright laws and is not for resale in any manner.

**PUBLICATION ORDERING INFORMATION**

**LITERATURE FULFILLMENT:**

Literature Distribution Center for ON Semiconductor  
19521 E. 32nd Pkwy, Aurora, Colorado 80011 USA  
**Phone:** 303-675-2175 or 800-344-3860 Toll Free USA/Canada  
**Fax:** 303-675-2176 or 800-344-3867 Toll Free USA/Canada  
**Email:** [orderlit@onsemi.com](mailto:orderlit@onsemi.com)

**N. American Technical Support:** 800-282-9855 Toll Free  
USA/Canada  
**Europe, Middle East and Africa Technical Support:**  
Phone: 421 33 790 2910

**ON Semiconductor Website:** [www.onsemi.com](http://www.onsemi.com)

**Order Literature:** <http://www.onsemi.com/orderlit>

For additional information, please contact your local Sales Representative

# Mouser Electronics

Authorized Distributor

Click to View Pricing, Inventory, Delivery & Lifecycle Information:

[ON Semiconductor:](#)

[NL37WZ14US](#) [NL37WZ14USG](#) [NLV37WZ14USG](#)