

# Notice for TAIYO YUDEN products

Please read this notice before using the TAIYO YUDEN products.

## ⚠️ REMINDERS

### ■ Product Information in this Catalog

Product information in this catalog is as of October 2019. All of the contents specified herein and production status of the products listed in this catalog are subject to change without notice due to technical improvement of our products, etc. Therefore, please check for the latest information carefully before practical application or use of our products.

Please note that TAIYO YUDEN shall not be in any way responsible for any damages and defects in products or equipment incorporating our products, which are caused under the conditions other than those specified in this catalog or individual product specification sheets.

### ■ Approval of Product Specifications

Please contact TAIYO YUDEN for further details of product specifications as the individual product specification sheets are available. When using our products, please be sure to approve our product specifications or make a written agreement on the product specification with TAIYO YUDEN in advance.

### ■ Pre-Evaluation in the Actual Equipment and Conditions

Please conduct validation and verification of our products in actual conditions of mounting and operating environment before using our products.

### ■ Limited Application

#### 1. Equipment Intended for Use

The products listed in this catalog are intended for general-purpose and standard use in general electronic equipment (e.g., AV equipment, OA equipment, home electric appliances, office equipment, information and communication equipment including, without limitation, mobile phone, and PC) and other equipment specified in this catalog or the individual product specification sheets.

TAIYO YUDEN has the line-up of the products intended for use in automotive electronic equipment, telecommunications infrastructure and industrial equipment, or medical devices classified as GHTF Classes A to C (Japan Classes I to III). Therefore, when using our products for these equipment, please check available applications specified in this catalog or the individual product specification sheets and use the corresponding products.

#### 2. Equipment Requiring Inquiry

Please be sure to contact TAIYO YUDEN for further information before using the products listed in this catalog for the following equipment (excluding intended equipment as specified in this catalog or the individual product specification sheets) which may cause loss of human life, bodily injury, serious property damage and/or serious public impact due to a failure or defect of the products and/or malfunction attributed thereto.

- (1) Transportation equipment (automotive powertrain control system, train control system, and ship control system, etc.)
- (2) Traffic signal equipment
- (3) Disaster prevention equipment, crime prevention equipment
- (4) Medical devices classified as GHTF Class C (Japan Class III)
- (5) Highly public information network equipment, data-processing equipment (telephone exchange, and base station, etc.)
- (6) Any other equipment requiring high levels of quality and/or reliability equal to the equipment listed above

#### 3. Equipment Prohibited for Use

Please do not incorporate our products into the following equipment requiring extremely high levels of safety and/or reliability.

- (1) Aerospace equipment (artificial satellite, rocket, etc.)
- (2) Aviation equipment \*<sup>1</sup>
- (3) Medical devices classified as GHTF Class D (Japan Class IV), implantable medical devices \*<sup>2</sup>

- (4) Power generation control equipment (nuclear power, hydroelectric power, thermal power plant control system, etc.)
- (5) Undersea equipment (submarine repeating equipment, underwater work equipment, etc.)
- (6) Military equipment
- (7) Any other equipment requiring extremely high levels of safety and/or reliability equal to the equipment listed above

\*Notes:

1. There is a possibility that our products can be used only for aviation equipment that does not directly affect the safe operation of aircraft (e.g., in-flight entertainment, cabin light, electric seat, cooking equipment) if such use meets requirements specified separately by TAIYO YUDEN. Please be sure to contact TAIYO YUDEN for further information before using our products for such aviation equipment.
2. Implantable medical devices contain not only internal unit which is implanted in a body, but also external unit which is connected to the internal unit.

#### 4. Limitation of Liability

Please note that unless you obtain prior written consent of TAIYO YUDEN, TAIYO YUDEN shall not be in any way responsible for any damages incurred by you or third parties arising from use of the products listed in this catalog for any equipment that is not intended for use by TAIYO YUDEN, or any equipment requiring inquiry to TAIYO YUDEN or prohibited for use by TAIYO YUDEN as described above.

### ■ Safety Design

When using our products for high safety and/or reliability-required equipment or circuits, please fully perform safety and/or reliability evaluation. In addition, please install (i) systems equipped with a protection circuit and a protection device and/or (ii) systems equipped with a redundant circuit or other system to prevent an unsafe status in the event of a single fault for a failsafe design to ensure safety.

### ■ Intellectual Property Rights

Information contained in this catalog is intended to convey examples of typical performances and/or applications of our products and is not intended to make any warranty with respect to the intellectual property rights or any other related rights of TAIYO YUDEN or any third parties nor grant any license under such rights.

### ■ Limited Warranty

Please note that the scope of warranty for our products is limited to the delivered our products themselves and TAIYO YUDEN shall not be in any way responsible for any damages resulting from a failure or defect in our products. Notwithstanding the foregoing, if there is a written agreement (e.g., supply and purchase agreement, quality assurance agreement) signed by TAIYO YUDEN and your company, TAIYO YUDEN will warrant our products in accordance with such agreement.

### ■ TAIYO YUDEN's Official Sales Channel

The contents of this catalog are applicable to our products which are purchased from our sales offices or authorized distributors (hereinafter "TAIYO YUDEN's official sales channel"). Please note that the contents of this catalog are not applicable to our products purchased from any seller other than TAIYO YUDEN's official sales channel.

### ■ Caution for Export

Some of our products listed in this catalog may require specific procedures for export according to "U.S. Export Administration Regulations", "Foreign Exchange and Foreign Trade Control Law" of Japan, and other applicable regulations. Should you have any questions on this matter, please contact our sales staff.



REFLOW

**PARTS NUMBER**

(A) Previous Rule (applied products registered on March 31, 2010 or before.)

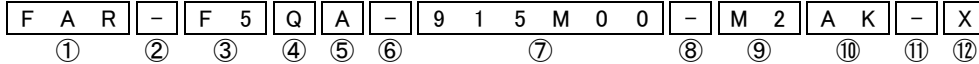

- ① Family
- ② Common sign
- ③ Series name
- ④ Package code
- ⑤ Product code
- ⑥ Common sign
- ⑦ Frequency
- ⑧ Common sign
- ⑨ Internal code
- ⑩ Internal code
- ⑪ Custom code
- ⑫ Packaging

Code	Product	Frequency Range [MHz]
D5	Duplexer	700 - 1000
D6	Duplexer	1000 - 5000
J5	Triplexer	700 - 1000
F5	Device	700 - 1000
F6	Device	1000 - 5000
G5	Dual Devices	700 - 1000
G6	Dual Devices	1000 - 5000

(B) New Rule (applied to products registered on April 1, 2010 or later.)

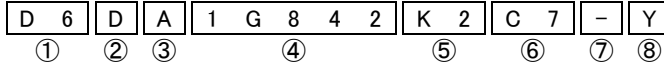

- ① Series name
- ② Package code
- ③ Product code
- ④ Frequency
- ⑤ Internal code
- ⑥ Internal code
- ⑦ Custom code
- ⑧ Packaging

Code	Product	Frequency Range [MHz]
D5	Duplexer	700 - 1000
D6	Duplexer	1000 - 5000
J5	Triplexer	700 - 1000
F5	Device	700 - 1000
F6	Device	1000 - 5000
G5	Dual Devices	700 - 1000
G6	Dual Devices	1000 - 5000
H6	Triple Devices	1000 - 5000
K6	Quadplexer	1000 - 5000

\*For further details, please contact to TAIYO YUDEN CO., LTD.

**EXTERNAL DIMENSIONS**

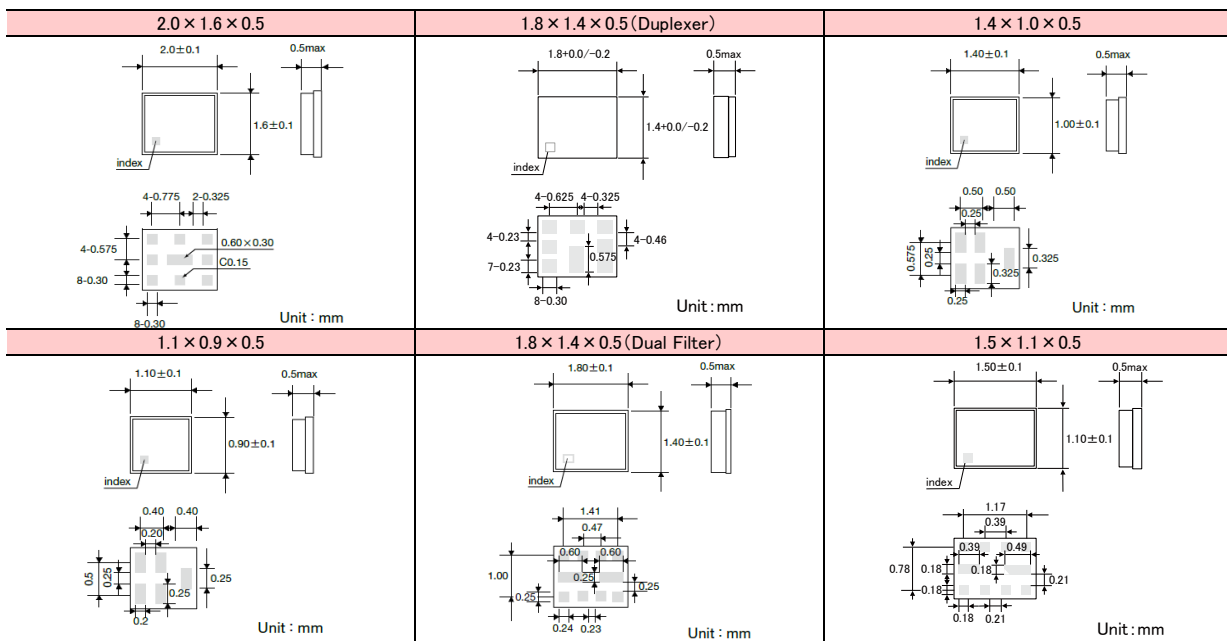

▶ This catalog contains the typical specification only due to the limitation of space. When you consider the purchase of our products, please check our product specification sheets. For details of each product (characteristics graph, reliability information, precautions for use, and so on), see our website (<http://www.ty-top.com/>).

■ PARTS NUMBER

● Duplexers

System	Part number	Package Size [mm]	Insertion Loss [dB]	Attenuation [dB]	Remarks	
Band 1	D6DA2G140K2A4	1.8 × 1.4 × 0.5 max.	1.8/1.8	56/51		
	D6DA2G140K2A7	1.8 × 1.4 × 0.5 max.	1.6/1.7	58/59		
	D6PE2G140P3AW	2.0 × 1.6 × 0.5 max.	1.5/1.6	59/47	Rx : Bal.100ohm	
	D6RB2G140E1AJ	1.8 × 1.4 × 0.5 max.	1.7/1.8	57/48	Rx : Bal.100ohm	
	D6RB2G140E1AL	1.8 × 1.4 × 0.47 max.	1.7/1.8	57/51	Rx : Bal.100ohm	
Band 2	D6PF1G960M3B6	2.0 × 1.6 × 0.57 max.	2.2/2.7	55/52		
	D6PF1G960M3B9	2.0 × 1.6 × 0.57 max.	2.2/2.7	57/52		
	D6DA1G960K2B1	1.8 × 1.4 × 0.57 max.	1.9/2.5	54/54		
	D6DA1G960K2B2	1.8 × 1.4 × 0.57 max.	1.8/2.3	55/55		
	D6PE1G960P3BY	2.0 × 1.6 × 0.57 max.	2.0/3.1	57/53	Rx : Bal.100ohm	
	D6PE1G960P3BP	2.0 × 1.6 × 0.57 max.	2.3/3.0	56/52	Rx : Bal.100ohm	
Band 3	D6RB1G960E1HB	1.8 × 1.4 × 0.6 max.	2.1/2.9	56/55	Rx : Bal.100ohm	
	D6DA1G842K2C4	1.8 × 1.4 × 0.6 max.	2.3/2.1	56/56		
Band 4	D6DA1G842K2C7	1.8 × 1.4 × 0.38 max.	1.8/1.9	60/56		
	D6DA2G132K2D4	1.8 × 1.4 × 0.5 max.	1.5/1.7	57/55		
Band 5	D6DA2G132K2D9	1.8 × 1.4 × 0.5 max.	1.6/1.8	60/56		
	D6PE2G132P3DWB	2.0 × 1.6 × 0.5 max.	1.8/1.8	55/50	Rx : Bal.100ohm	
	D6RB2G132E1DF	1.8 × 1.4 × 0.5 max.	1.6/1.8	62/54	Rx : Bal.100ohm	
	D5DA881M5K2E4	1.8 × 1.4 × 0.5 max.	1.4/1.7	58/59		
Band 7	D5RB881M5E1BH	1.8 × 1.4 × 0.47 max.	1.4/1.7	58/52	Rx : Bal.100ohm	
	D6HL2G655DL06	2.0 × 1.6 × 0.54 max.	2.1/2.3	53/57	FBAR	
	D6HQ2G655DP01	1.8 × 1.4 × 0.54 max.	2.3/2.2	58/57	FBAR	
	D6HQ2G655DP02	1.8 × 1.4 × 0.54 max.	2.0/2.0	58/55	FBAR 2HD Improved	
	D6HQ2G655DP03	1.8 × 1.4 × 0.54 max.	2.0/2.0	61/56		
	D6DA2G655K2F1	1.8 × 1.4 × 0.44 max.	2.1/2.2	50/50		
	D6HN2G655BN54	2.0 × 1.6 × 0.54 max.	1.8/2.6	55/56	Rx : Bal.100ohm, FBAR WLAN coexistence Ver.	
	D6HP2G655BP11	1.8 × 1.4 × 0.54 max.	1.8/2.4	56/56	Rx : Bal.100ohm, FBAR	
	Band 8	D5PF942M5M3G6	2.0 × 1.6 × 0.5 max.	2.1/2.1	57/55	for LTE
		D5PF942M5M3G9	2.0 × 1.6 × 0.5 max.	1.9/2.2	60/52	
D5DA942M5K2G6		1.8 × 1.4 × 0.5 max.	1.7/1.8	58/59		
D5DA942M5K2S2		1.8 × 1.4 × 0.6 max.	1.3/1.5	58/56	for LTE	
D5PE942M5P3GT		2.0 × 1.6 × 0.5 max.	1.8/2.2	60/55	Rx : Bal.100ohm	
Band 11	D5RB942M5E1CF	1.8 × 1.4 × 0.5 max.	1.5/1.9	56/51	Rx : Bal.100ohm	
	D6DA1G485K2W1	1.8 × 1.4 × 0.44 max.	1.2/1.3	58/60		
Band 12	D5DA737M5K2H2	1.8 × 1.4 × 0.5 max.	1.65/1.65	63/58		
Band 13	D5PE782M0M3P9	2.0 × 1.6 × 0.5 max.	1.6/2.0	64/55		
	D5DA782M0K2J6	1.8 × 1.4 × 0.5 max.	1.9/1.7	58/61		
Band 14	D5DA793M0K2K2	1.8 × 1.4 × 0.44 max.	1.2/2.2	50/50		
Band 17	D5PF740M0M3R9	2.0 × 1.6 × 0.5 max.	1.6/1.8	61/66		
	D5DA740M0K2L4	1.8 × 1.4 × 0.5 max.	1.25/1.65	65/60		
Band 20	D5FC847M0K3NE	1.8 × 1.4 × 0.44 max.	1.8/1.8	55/56		
Band 21	D6DA1G503K2Y1	1.8 × 1.4 × 0.44 max.	1.3/1.3	60/60		
	D6PE1G503P3KW	2.0 × 1.6 × 0.5 max.	1.6/2.0	55/56	Rx : Bal.100ohm	
Band 25	D6HQ1G962DP35	1.8 × 1.4 × 0.57 max.	2.5/2.6	57/57	FBAR	
Band 26	D5PF876M5M3U9	2.0 × 1.6 × 0.5 max.	2.0/1.9	56/49		
	D5DA876M5K2P6	1.8 × 1.4 × 0.6 max.	1.3/2.0	60/57		
	D5PE876M5P3UZ	2.0 × 1.6 × 0.5 max.	2.2/2.6	60/49	Rx : Bal.100ohm	
Band 28	D5PF773M0M3Y6	2.0 × 1.6 × 0.5 max.	1.8/2.3	60/53	Block A	
	D5FC773M0K3NC	1.8 × 1.4 × 0.44 max.	2.5/2.6	57/57		
	D5PF788M0M3Y9	2.0 × 1.6 × 0.5 max.	1.8/2.4	60/54	Block B	
	D5FC788M0K3ND	1.8 × 1.4 × 0.44 max.	1.8/1.9	63/60		
Band 66	D6DA2G155K2T2	1.8 × 1.4 × 0.44 max.	2.0/2.0	57/54		

● Multiplexers

System	Part number	Package Size [mm]	Insertion Loss [dB]	Attenuation [dB]	Remarks
Band 13+17 Triplexer	J5NA782M0P1H6	2.5 × 2.0 × 0.6 max.	1.6/1.9	60/49	
			1.9/1.9	53/55	
Band 1+3 Quadplexer	K6QZ2G140Q3ZA	2.5 × 2.0 × 0.8 max.	1.9/2.0	56/55	
			1.7/2.3	56/54	
	K6QZ2G140Q3ZC	2.5 × 2.0 × 0.8 max.	2.0/1.9	55/57	
			2.4/2.3	57/58	

▶ This catalog contains the typical specification only due to the limitation of space. When you consider the purchase of our products, please check our product specification sheets. For details of each product (characteristics graph, reliability information, precautions for use, and so on), see our website (<http://www.ty-top.com/>).

HIGH FREQUENCY PRODUCTS

■ PARTS NUMBER

● W-CDMA / LTE / CDMA 2000 Filters

System	Part number	Package Size [mm]	Insertion Loss [dB]	Attenuation [dB]	Remarks
Band 1 Tx	F6QA1G950M2AA	1.1 × 0.9 × 0.5 max.	1.8	38	
Band 1, Band 4 Rx	F6QA2G140M2AM	1.1 × 0.9 × 0.5 max.	1.9	46	
	F6QG2G140P2KA	1.1 × 0.9 × 0.5 max.	1.7	55	100ohm output
Band 2 Tx BC1 (PCS) Tx	F6QA1G880M2AQ	1.1 × 0.9 × 0.5 max.	1.7	20	
Band 2 Rx BC1 (PCS) Rx	F6QA1G960M2AP	1.1 × 0.9 × 0.5 max.	2.8	39	High Att.
	F6QG1G960P2KT	1.1 × 0.9 × 0.5 max.	2.8	44	100ohm output
Band 3 Tx	F6QA1G747M2QS	1.1 × 0.9 × 0.5 max.	2.1	22	
Band 3 Rx	F6QA1G842M2AN	1.1 × 0.9 × 0.5 max.	2.0	38	
	F6QG1G842P2KD	1.1 × 0.9 × 0.5 max.	3.2	45	100ohm output
Band 5 Tx BC0 Tx	F5QA836M5M2AR	1.1 × 0.9 × 0.5 max.	1.9	45	High Att.
Band 5 Rx BC0 Rx	F5QA881M5M2AU	1.1 × 0.9 × 0.5 max.	1.3	51	Low Loss/high Att.
	F5QG881M5P2KG	1.1 × 0.9 × 0.5 max.	1.5	56	100ohm output
Band 7 Rx	F6QA2G655M2QH	1.1 × 0.9 × 0.5 max.	2.5	38	
	F6QG2G655P2KE	1.1 × 0.9 × 0.5 max.	2.5	52	100ohm. High Att.
Band 8 Tx	F5QA897M5M2AC	1.1 × 0.9 × 0.5 max.	2.3	18	
Band 8 Rx	F5QA942M5M2AW	1.1 × 0.9 × 0.5 max.	2.0	48	for LTE
	F5QG942M5P2KB	1.1 × 0.9 × 0.5 max.	2.2	56	100ohm output
	F5QG942M5P2KF	1.1 × 0.9 × 0.5 max.	2.2	60	100ohm output for LTE
Band 12 Rx	F5QA737M5M2QN	1.1 × 0.9 × 0.5 max.	1.6	53	
	F5QG737M5P2KK	1.1 × 0.9 × 0.5 max.	1.6	55	100ohm output
Band 13 Tx	F5QA782M0M2AZ	1.1 × 0.9 × 0.5 max.	1.5	56	
Band 13 Rx	F5QA751M0M2QM	1.1 × 0.9 × 0.5 max.	1.9	50	
Band 14	F5QA763M0M2QL	1.1 × 0.9 × 0.5 max.	2.2	49	
Band 17 Tx	F5QA710M0M2AY	1.1 × 0.9 × 0.5 max.	1.3	33	
Band 17 Rx	F5QG740M0P2KH	1.1 × 0.9 × 0.5 max.	1.4	65	100ohm output
Band 20 Rx	F5QA806M0M2QE	1.1 × 0.9 × 0.5 max.	2.7	41	
Band 21 Rx	F6QA1G503M2QF	1.1 × 0.9 × 0.5 max.	2.0	52	
Band 25 Tx	F6QA1G882M2AS	1.1 × 0.9 × 0.5 max.	1.8	23	
Band 26 Rx	F5QA876M5M2QP	1.1 × 0.9 × 0.5 max.	2.2	49	
	F5QG876M5P2KQ	1.1 × 0.9 × 0.5 max.	2.2	59	100ohm output
Band 28 Rx	F5QA773M0M2QC	1.1 × 0.9 × 0.5 max.	2.1	52	Block A
	F5QA788M0M2QB	1.1 × 0.9 × 0.5 max.	2.0	52	Block B
Band 29 Rx	F5BA722M5M6UW	1.1 × 0.9 × 0.44 max.	1.6	-	
Band 30 Rx	F6QP2G355R2SE	1.1 × 0.9 × 0.5 max.	2.1	50	
Band 32 Rx	F6QA1G474H2JS	1.1 × 0.9 × 0.5 max.	1.8	-	
Band 66 Rx	F6BA2G155M6UU	1.1 × 0.9 × 0.44 max.	1.7	45	
Band 67 Rx	F5QA748M0M2WF	1.1 × 0.9 × 0.5 max.	1.5	-	

● W-CDMA / LTE Dual Filters

System	Part number	Package Size [mm]	Insertion Loss [dB]	Attenuation [dB]	Remarks
Band 3+1 Rx (Common Input)	G6QN2G140M2RN	1.5 × 1.1 × 0.5 max.	2.0/1.7	40/52	For B1+B3 CA

● TDD Filters (TD-SCDMA / TD-LTE)

System	Part number	Package Size [mm]	Insertion Loss [dB]	Attenuation [dB]	Remarks
Band 34 TRx	F6FC2G017H4PC	1.1 × 0.9 × 0.44 max.	1.1	-	Input Power +29dBm (TDD:50% Duty)
Band 34 Rx	F6QP2G017R2SF	1.1 × 0.9 × 0.5 max.	1.3	-	
Band 38 Tx	F6KA2G595A4VL	1.4 × 1.0 × 0.5 max.	1.5	-	Input Power +29dBm
Band 38 Rx	F6QA2G595M2QK	1.1 × 0.9 × 0.5 max.	1.9	-	
	F6QB2G595P2BS	1.1 × 0.9 × 0.5 max.	2.0	-	Balanced 100ohm
Band 39 TRx	F6FC1G900H4PB	1.1 × 0.9 × 0.44 max.	1.1	-	Input power +29dBm (Duty 50%)
Band 39 Rx	F6QA1G900M2WD	1.1 × 0.9 × 0.5 max.	1.5	-	
Band 40 Tx	F6HH2G350EH75	1.1 × 0.9 × 0.44 max.	1.4	-	Input power +30.0dBm TD-LTE 40% duty 5MHz 1RB FBAR
Band 40 Rx	F6QA2G350M2QA	1.1 × 0.9 × 0.5 max.	2.2	-	
	F6QB2G350P2BH	1.1 × 0.9 × 0.5 max.	2.8	-	Balanced 100ohm
Band 41 TRx	F6KA2G605A4LA	1.4 × 1.0 × 0.5 max.	2.4	-	Unbal High power design 2555-2655MHz BW100MHz
	F6FC2G600H4PA	1.1 × 0.9 × 0.44 max.	2.1	-	Unbal High power design & HPUE for CMCC 2535-2655MHz BW120MHz
	F6FC2G595H4PD	1.1 × 0.9 × 0.44 max.	1.7	-	Unbal Improved IL High power design & HPUE for CMCC 2535-2655MHz BW120MHz
	F6HP2G593AP20	2.0 × 1.6 × 0.6 max.	2.9	-	Unbal High power design 2496-2690MHz BW194MHz FBAR
	F6HQ2G593AP31	1.8 × 1.4 × 0.57 max.	2.7	-	Unbal High power design & HPUE for Sprint 2496-2690MHz BW194MHz FBAR

● TDD Dual Filters (TD-SCDMA / TD-LTE)

System	Part number	Package Size [mm]	Insertion Loss [dB]	Attenuation [dB]	Remarks
Band 34 + Band 39 TRx	G6FT2G017G2YA	1.5 × 1.1 × 0.44 max.	1.3/1.4	-	1 IN / 3 OUT
Band 39 + Band 34 + Band 41 (BW120MHz) DRx	H6FM2G595T2MZ	1.8 × 1.4 × 0.44 max.	1.3/1.4/2.7	-	1 IN / 3 OUT
Band 39 Rx + 41 (BW100MHz) TRx (Common Input)	G6KJ2G605D4AB	1.8 × 1.4 × 0.5 max.	2.1/2.6	-	B41 High power design B41 (2555-2655MHz BW100MHz) for CMCC CA
Band 41 Rx + 39 (BW100MHz) DRx (Common Input)	G6QN2G605M2RM	1.5 × 1.1 × 0.5 max.	2.2/1.3	-	
Band 41 (BW120MHz) Rx + 39Rx (Common Input)	G6QN2G595M2RP	1.5 × 1.1 × 0.5 max.	2.3/1.3	-	

▶ This catalog contains the typical specification only due to the limitation of space. When you consider the purchase of our products, please check our product specification sheets. For details of each product (characteristics graph, reliability information, precautions for use, and so on), see our website (<http://www.ty-top.com/>).

## PARTS NUMBER

## ● GPS

System	Part number	Package Size [mm]	Insertion Loss [dB]	Attenuation [dB]	Remarks
GPS	F6QA1G575H2JF	1.1 × 0.9 × 0.5 max.	0.96	-	Low loss, High Att.
GPS (GNSS)	F6QA1G585M2AT	1.1 × 0.9 × 0.5 max.	1.4	-	
	F6QB1G585P2BQ	1.1 × 0.9 × 0.5 max.	1.7	-	100ohm output
GPS+GLONASS+Galileo+Compass	F6QA1G581M2QZ	1.1 × 0.9 × 0.5 max.	1.4	-	
	F6QA1G582H2JM	1.1 × 0.9 × 0.5 max.	1.8	-	Ladder High Att.
	F6BG1G582R6TT	1.1 × 0.9 × 0.44 max.	1.7	-	100ohm output
GNSS (L2+L5+B2)	F6FC1G197H4PF	1.1 × 0.9 × 0.44 max.	1.3	-	

## ● Others

System	Part number	Package Size [mm]	Insertion Loss [dB]	Attenuation [dB]	Remarks
ISM900 (B.W.26MHz)	FAR-F5QA-915M00-M2AK	1.1 × 0.9 × 0.5 max.	1.8	-	
Wireless LAN / Bluetooth®	F6KA2G436A4VE	1.4 × 1.0 × 0.5 max.	2.5	-	2400-2472MHz,+24dBm 2.5GHz High Att (for MTK)
	F6KA2G466A4VJ	1.4 × 1.0 × 0.5 max.	2.8	-	2432-2500MHz,+24dBm 2.3GHz High Att (for MTK)
	F6HG2G441EG65	1.1 × 0.9 × 0.5 max.	1.3	-	FBAR
	F6HG2G441EG66	1.1 × 0.9 × 0.5 max.	1.3	-	High Att. @2.38GHz FBAR
	F6FC2G441H4PE	1.1 × 0.9 × 0.44 max.	1.0	-	SAW

# FBAR/SAW DEVICES for MOBILE COMMUNICATIONS

## PACKAGING

### ① Minimum Quantity

Type	Size [mm]	Code & Quantity [pcs]					
		Standard		Option			
Duplexer	2.0 × 1.6	Y	15000	Z	3000		
	1.8 × 1.4	Y	15000	Z	3000		
Quadplexer	2.5 × 2.0	U	10000	Z	3000		
Triplexer	2.5 × 2.0	U	10000	Z	3000		
Single Filter	2.0 × 1.6	Y	15000	Z	3000		
	1.8 × 1.4	Y	15000	Z	3000		
	1.4 × 1.0	Y	15000	Z	3000		
	1.1 × 0.9	X	10000	Y	15000	J	5000
Dual Filter	1.8 × 1.4	Y	15000	Z	3000		
	1.5 × 1.1	Y	15000	J	5000		
Triple Filter	1.8 × 1.4	Y	15000	Z	3000		

### ② Tape material

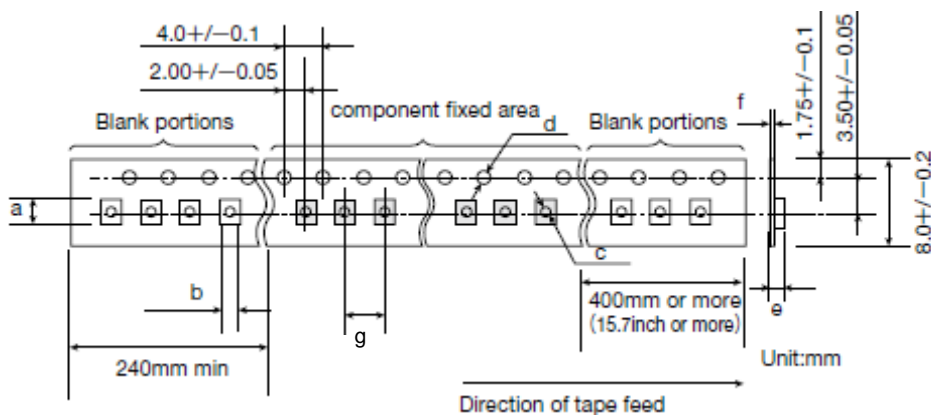

### ● Taping dimensions

Type	Size[mm]	a	b	c	d	e	f	g
Duplexer	2.0 × 1.6	2.4 ± 0.1	2.0 ± 0.1	1.05 ± 0.05	1.5 + 0.1 / - 0	0.90 - 0.05	0.25 ± 0.05	4.0 ± 0.1
	1.8 × 1.4	2.2 ± 0.1	1.8 ± 0.1	0.5 ± 0.05	1.55 ± 0.05	0.8 ± 0.1	0.30 ± 0.05	4.0 ± 0.1
Quadplexer	2.5 × 2.0	2.8 ± 0.1	2.3 ± 0.1	1.5 + 0.1 / - 0	1.5 + 0.1 / - 0	1.0 + 0.1 / - 0.0	0.25 ± 0.05	4.0 ± 0.1
Triplexer	2.5 × 2.0	2.8 ± 0.1	2.3 ± 0.1	1.5 + 0.1 / - 0	1.5 + 0.1 / - 0	1.0 + 0.1 / - 0.0	0.25 ± 0.05	4.0 ± 0.1
Single Filter	2.0 × 1.6	2.4 ± 0.1	2.0 ± 0.1	1.05 ± 0.05	1.5 + 0.1 / - 0	0.90 - 0.05	0.25 ± 0.05	4.0 ± 0.1
	1.8 × 1.4	2.2 ± 0.1	1.8 ± 0.1	0.5 ± 0.05	1.55 ± 0.05	0.8 ± 0.1	0.30 ± 0.05	4.0 ± 0.1
	1.4 × 1.0	1.7 ± 0.1	1.3 ± 0.1	0.5 ± 0.05	1.5 + 0.1 / - 0	0.63 ± 0.05	0.20 ± 0.05	4.0 ± 0.1
	1.1 × 0.9	1.3 ± 0.1	1.1 ± 0.1	0.5 ± 0.05	1.55 ± 0.05	0.63 ± 0.05	0.20 ± 0.05	2.0 ± 0.05
Dual Filter	1.8 × 1.4	2.2 ± 0.1	1.8 ± 0.1	0.5 ± 0.05	1.55 ± 0.05	0.8 ± 0.1	0.30 ± 0.05	4.0 ± 0.1
	1.5 × 1.1	1.8 ± 0.1	1.4 ± 0.1	0.5 ± 0.05	1.5 + 0.1 / - 0	0.7 ± 0.1	0.25 ± 0.05	4.0 ± 0.1
Triple Filter	1.8 × 1.4	2.2 ± 0.1	1.8 ± 0.1	0.5 ± 0.05	1.55 ± 0.05	0.8 ± 0.1	0.30 ± 0.05	4.0 ± 0.1

単位: mm

### ● Material of Tape (Conductive)

Tape : Polystyrene

Top cover tape : Polyethylene terephthalate (PET) and Polyethylene

### ③ Top Tape Strength

The top tape requires a peel-off force of 0.1 to 1.0N in the direction of the arrow as illustrated below.

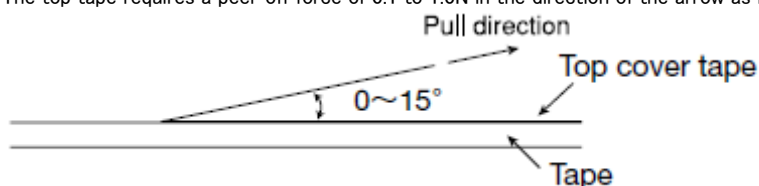

▶ This catalog contains the typical specification only due to the limitation of space. When you consider the purchase of our products, please check our specification. For details of each product (characteristics graph, reliability information, precautions for use, and so on), see our Web site (<http://www.ty-top.com/>).

#### ④ Reel size

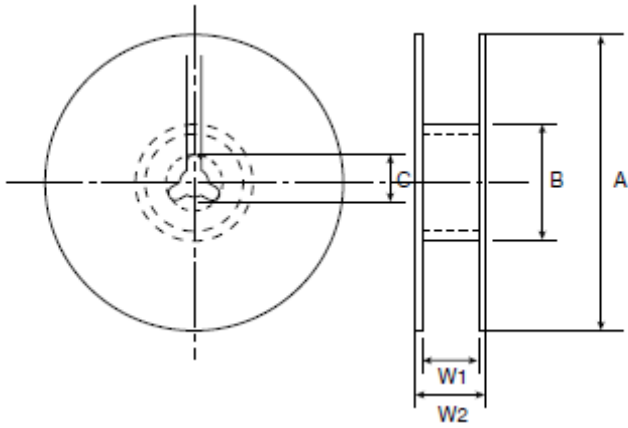

#### ● Material of Reel

Material : Polystyrene + Carbon

Characteristics : Conform to EIAJ-ET-7200A

Color : Black

Surface resistance (reference value) : 109 Ω/sq Max.

Code	Quantity	A	B	C	W1	W2
X	10,000 pcs	φ 180.0 +0.0/-1.5	φ 66.0 ±0.5	φ 13.0 ±0.2	9.0 +1.0/-0.0	11.4 ±1.0
U	10,000 pcs	φ 180.0 +0.0/-1.5	φ 66.0 ±0.5	φ 13.0 ±0.2	9.0 +1.0/-0.0	11.4 ±1.0
Y	15,000 pcs	φ 330.0 ±2.0	φ 100.0 ±1.0	φ 13.0 ±0.2	9.4 ±1.0	13.4 ±1.0
J	5,000 pcs	φ 180.0 +0.0/-1.5	φ 66.0 ±0.5	φ 13.0 ±0.2	9.0 +1.0/-0.0	11.4 ±1.0
Z	3,000 pcs	φ 180.0 +0.0/-1.5	φ 66.0 ±0.5	φ 13.0 ±0.2	9.0 +1.0/-0.0	11.4 ±1.0

Unit : mm

#### ⑤ Reel label and Reel C-Label sticking and Winding method

#### ● Surface

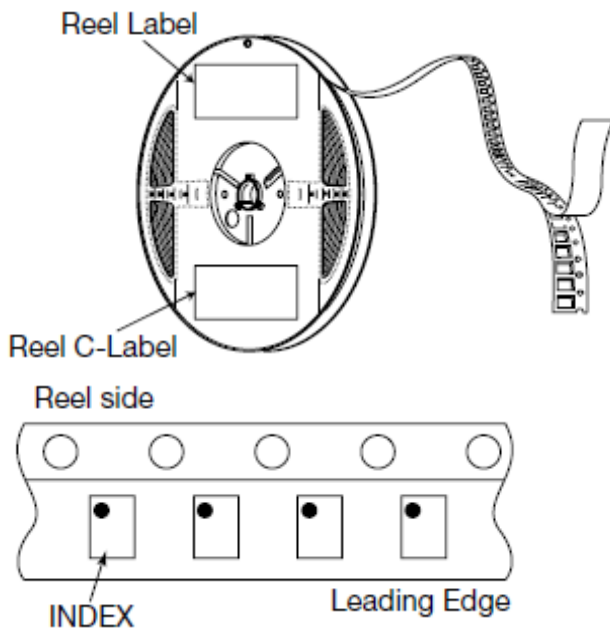

# FBAR/SAW DEVICES for MOBILE COMMUNICATIONS

## RELIABILITY DATA

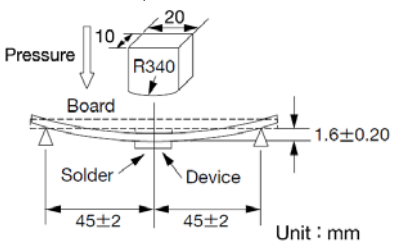
1. Terminal strength	
Specified Value	No damage to be found.
Test Methods and Remarks	<p>Bend width 4mm, hold for <math>5 \pm 1</math> sec.</p>  <p>Unit : mm</p>
2. Mechanical shock	
Specified Value	After testing, meet the specified characteristics at a room temperature.
Test Methods and Remarks	Apply $14700\text{m/s}^2$ for 0.5ms 5 times for each of 6 directions.
3. Vibration	
Specified Value	After testing, meet the specified characteristics at a room temperature.
Test Methods and Remarks	With 1.5 mm of whole amplitude at 10 to 55 Hz of frequency, and $98\text{m/s}^2$ of acceleration at 55 to 500Hz, apply a vibration for 2 hours for each of 3 directions, period is 15 minutes(10 to 500 to 10Hz)
4. Drop 1	
Specified Value	After testing, meet the specified characteristics at a room temperature.
Test Methods and Remarks	Drop 3 times onto concrete floor from the height of 1.0m.
5. Drop 2	
Specified Value	After testing, meet the specified characteristics at a room temperature.
Test Methods and Remarks	Drop with 150g weight 3 times in each 6 direction onto concrete floor from the height of 1.8m.
6. Temperature cycling	
Specified Value	After testing, meet the specified characteristics at a room temperature.
Test Methods and Remarks	Temp. range $-40$ to $+100^\circ\text{C}$ . 500cycle.
7. Static humidity	
Specified Value	After testing, meet the specified characteristics at a room temperature.
Test Methods and Remarks	<p>SAW : <math>+85^\circ\text{C}</math>, 90% to 95%RH, apply DC5V, 1000hours.</p> <p>FBAR : <math>+85^\circ\text{C}</math>, 90% to 95%RH, apply DC0V, 1000hours.</p>
8. High temperature storage life	
Specified Value	After testing, meet the specified characteristics at a room temperature.
Test Methods and Remarks	$+100^\circ\text{C}$ , 1000hours.
9. Low temperature storage life	
Specified Value	After testing, meet the specified characteristics at a room temperature.
Test Methods and Remarks	$-40^\circ\text{C}$ , 1000hours.

▶ This catalog contains the typical specification only due to the limitation of space. When you consider the purchase of our products, please check our specification. For details of each product (characteristics graph, reliability information, precautions for use, and so on), see our Web site (<http://www.ty-top.com/>).



10. High Temperature Bias	
Specified Value	After testing, meet the specified characteristics at a room temperature.
Test Methods and Remarks	Please refer to individual specifications in detail.
11. Solderability	
Specified Value	More than 90% of area of terminals to be covered with the solder. A change of the remarkable appearance do not have it.
Test Methods and Remarks	Lead-free Solder paste, Reflow ; Peak temperature 245°C
12. Solder heat resistance	
Specified Value	After testing, meet the specified characteristics at a room temperature. A change of the remarkable appearance do not have it.
Test Methods and Remarks	<p>◆ Recommended temperature profile of reflow soldering Figure shows recommended temperature profile of reflow soldering in the case of lead-free solder alloy Sn3.0Ag0.5Cu. Suitable condition for solder heating is differed depending on composition and manufacturing method. Please contact to solder manufacturer for the details.</p> <p>Temperature (°C)</p> <p>Ambient temperature rise slope : 1~4°C/sec.</p> <p>Pre-Heating 150~180°C</p> <p>50~110sec.</p> <p>30~50sec.</p> <p>Temperature in heat condition : 230°Cmin. 50sec. max. Temperature of upper surface of package and PCB surface. : 260°Cmin. 10sec. max.</p> <p>Ambient temperature cool slope : 1~4°C/sec.</p> <p>10sec.</p>

※ According to JIS(IEC) standard.

# FBAR/SAW DEVICES for MOBILE COMMUNICATIONS

## ■ PRECAUTIONS

### 1. Storage conditions

Precautions	<p>◆Storage</p> <p>1. To maintain the solderability of terminal electrodes and to keep the packaging material in good condition, care must be taken to control temperature and humidity in the storage area. Humidity should especially be kept as low as possible.</p> <ul style="list-style-type: none"><li>• Recommended conditions Ambient temperature : <math>-5 \sim +40^{\circ}\text{C}</math> Humidity : 40~85%RH The ambient temperature must be kept below <math>30^{\circ}\text{C}</math>. Even under ideal storage conditions, the solderability of electrodes decreases gradually, so filters should be mounted within 1 year from the time of delivery.</li><li>• The packaging material should be kept where no chlorine or sulfur exists in the air.</li></ul>
Technical considerations	<p>◆Storage</p> <p>1. If the parts are stocked in a high temperature and humidity environment, problems such as reduced solderability caused by oxidation of terminal electrodes and deterioration of taping/ packaging materials may take place. For this reason, components should be used within 1 year from the time of delivery. If exceeding the above period, please check the solderability before using the filter.</p>

- Please contact our sales offices for further details of specifications.  
All of the standard values listed here are subject to change without notice.  
Therefore, please check the specifications carefully before use.

# Mouser Electronics

Authorized Distributor

Click to View Pricing, Inventory, Delivery & Lifecycle Information:

## Taiyo Yuden:

[D6HH1G960BH95-Z](#) [D6NF1G960P1BR-Z](#) [F5KY878M0B4ND-Z](#) [F5QB881M5P2BG-J](#) [F6KA2G535L4AM-Z](#)  
[F6KY1G960B4NF-Z](#) [D6PF1G960M3B6-Z](#) [F6QG2G140P2KA-J](#) [D6JG2G132D3GZ-Z](#) [F5QG881M5P2KG-J](#)  
[F5QG942M5P2KB-J](#) [F6QB1G585P2BQ-J](#) [F5KY-751M00-B4UQ-Z](#) [F6KA2G436A4VE-Z](#) [D6PE1G960P3BY-Z](#)  
[F5QA836M5M2AR-J](#) [F6QA1G950M2AA-J](#) [F6QA1G960M2AP-J](#) [F5QA897M5M2AC-J](#) [D5PF782M0M3P9-Z](#)  
[D6PF2G132M3D9-Z](#) [F6QA1G581M2QZ-J](#) [F6BG1G582R6TT-J](#) [D6DA1G842K2C4-Z](#) [D6DA2G140K2A7-Z](#)  
[D5DA942M5K2S2-Z](#) [D6DA2G132K2D9-Z](#) [D6HQ1G962DP39-Z](#) [D5PF740M0M3R9-Z](#) [F5QA737M5M2QN-J](#)  
[F6KA2G466A4VJ-Z](#) [D5DA881M5K2E4-Z](#) [D5PE876M5P3UZ-Z](#) [D5PF773M0M3Y6-Z](#) [D6HL1G962DL39-Z](#)  
[D6HL2G655DL06-Z](#) [D6HN2G655BN54-Z](#) [D6PE1G503P3KW-Z](#) [D6PE2G140P3AW-Z](#) [D6RB2G132E1DF-Z](#)  
[D6RB2G140E1AL-Z](#) [F5QA710M0M2AY-J](#) [F5QA773M0M2QC-J](#) [F5QA788M0M2QB-J](#) [F5QG740M0P2KH-J](#)  
[F5QG876M5P2KQ-J](#) [F5QG942M5P2KF-J](#) [F6HF2G350AF41-Z](#) [F6HP2G593AP20-Z](#) [F6KA2G605A4LA-Z](#)  
[F6QA1G503M2QF-J](#) [F6QA1G882M2AS-J](#) [F6QA2G595M2QK-J](#) [F6QB2G595P2BS-J](#) [F6QG1G842P2KD-J](#)  
[F5QA876M5M2QP-J](#) [F5QA751M0M2QM-J](#) [D5DA876M5K2P6-Z](#) [D6DA2G132K2D4-Z](#) [D5PF876M5M3U9-Z](#)  
[F6HQ2G593AP31-Z](#) [G6QN2G017M2RF-J](#) [D6HQ2G655DP02-Z](#) [D6DA1G960K2B2-Z](#) [F6FC1G900H4PB-J](#)  
[F6QA2G655M2QH-J](#) [F6FC2G600H4PA-J](#) [G6QN2G605M2RM-J](#) [D6HQ1G962DP35-Z](#) [D6RB1G960E1HB-Z](#)  
[F5KA707M5D4JW-Z](#) [F5KA833M0D4DU-Z](#) [F6KB2G350B4HT-Z](#) [D5NE782M0P1D6-Z](#) [D6HL2G655DL09-Z](#)  
[F6KA1G581D4JR-Z](#) [F5KA942M5D4MYBZ](#) [F6KA2G595A4VL-Z](#) [F6QB1G960P2BK-J](#) [D5DA737M5K2H2-Z](#)  
[D5DA782M0K2J6-Z](#) [D6HQ2G655DP01-Z](#) [G6QL2G140M2PA-J](#) [D5PF788M0M3Y9-Z](#) [D5RB942M5E1CF-Z](#)  
[D6DA2G140K2A4-Z](#) [D6PE2G132P3DWBZ](#) [D6RB2G140E1AJ-Z](#) [G5QT942M5N2VA-J](#) [G6QC1G960N2CH-J](#)  
[G6QD1G960N2DY-J](#) [G6QE1G960N2EE-J](#) [G6QE2G595N2EJ-J](#) [G6QH2G140N2LP-J](#) [G6QJ2G017M2MD-J](#)  
[G6QN2G017M2RD-J](#) [D6HK1G960DK12-Z](#) [D6NH1G960M1Z6-Z](#) [F6QG2G655P2KE-J](#) [G5QH942M5N2LN-J](#)